

**EVALUATION KIT
AVAILABLE**



Automotive Contact Monitor and Level Shifter

MAX13036

General Description

The MAX13036 automotive contact monitor and level shifter monitors and debounces eight remote mechanical switches and asserts an interrupt (INT) if a switch changes state. The state of each switch is sampled through an SPI™ interface by reading the status register and any switch can be prohibited from asserting an interrupt by writing to the command register. Four of the switch inputs are intended for ground-connected switches (IN0–IN3), and the other four inputs (IN4–IN7), are programmable in groups of two for either ground-connected or battery-connected switches. Two switch inputs (IN0, IN1) have direct level-shifted outputs (DO0, DO1) to be used for PWM or other timing-based signals.

Switch input thresholds are set to 50% of the voltage applied to BATREF. The threshold hysteresis is set by connecting an external resistor from HYST to ground. The MAX13036 supplies an adjustable wetting current to each closed switch to clean mechanical switching contacts that are exposed to adverse conditions.

The MAX13036 operates with a +6V to +26V battery voltage applied to BAT. A separate +2.7V to +5.5V logic supply input (VL) sets the interface voltage. The MAX13036 is available in a 5mm x 5mm 28-pin TQFN package and operates over the -40°C to +125°C temperature range.

Applications

Body Computers	Electric Sunroofs
Window Lifters	Other Control ECUs
Seat Movers	

Pin Configuration

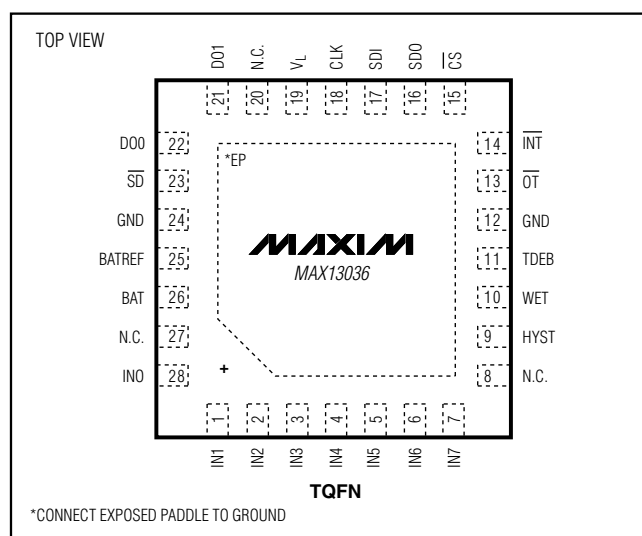

Features

- ◆ +6V to +26V Operating Voltage Range
- ◆ +42V Compatibility on BAT
- ◆ Inputs Withstand Reverse Battery
- ◆ Withstands Dynamic Battery Voltage Drop While VL is Present
- ◆ Ultra-Low Operating Current 17μA (typ) in Scan Mode
- ◆ Resistor-Adjustable Switching Hysteresis
- ◆ CMOS-Compatible Logic Outputs (+2.7V min)
- ◆ Built-In Switch Debouncing
- ◆ Interrupt Output
- ◆ Immunity to Transients
- ◆ High Modularity
- ◆ Thermal Protection
- ◆ ±8kV HBM ESD Protection on IN0–IN7 Without External Components
- ◆ Two Inputs (IN0, IN1) Programmable as Direct Outputs
- ◆ Four Inputs (IN4–IN7) Programmable for BAT or GND Related Switches

Ordering Information

PART	TEMP RANGE	PIN-PACKAGE	PKG CODE
MAX13036ATI+	-40°C to +125°C	28 TQFN-EP* (5mm x 5mm)	T2855-8

+ Denotes lead-free package.
*EP = Exposed paddle.

Typical Application Circuit appears at end of data sheet.

SPI is a trademark of Motorola, Inc.



Automotive Contact Monitor and Level Shifter

ABSOLUTE MAXIMUM RATINGS

(All voltages referenced to GND, unless otherwise noted.)

V _L	-0.3V to +6.0V	Continuous Current (\overline{CS} , CLK, SDI, SDO, DO0, DO1).....	±20mA
BAT.....	-0.3V to +42V	HBM ESD Protection (IN0–IN7).....	±8kV
BATREF, IN ₋ to BAT.....	-45V to +45V	Continuous Power Dissipation (T _A = +70°C, multilayer board)	
BATREF, IN ₋ to GND.....	-45V to +45V	28-Pin TQFN (derate 34.5mW/°C above +70°C).....	2759mW
SD.....	-0.3V to +45V	Operating Temperature Range.....	-40°C to +125°C
HYST, WET, TDEB, OT, INT.....	-0.3V to 6.0V	Junction Temperature.....	+150°C
CS, CLK, SDI, SDO, DO0, DO1.....	-0.3V to (V _L + 0.3V)	Storage Temperature Range.....	-65°C to +150°C
		Lead Temperature (soldering, 10s).....	+300°C

Stresses beyond those listed under “Absolute Maximum Ratings” may cause permanent damage to the device. These are stress ratings only, and functional operation of the device at these or any other conditions beyond those indicated in the operational sections of the specifications is not implied. Exposure to absolute maximum rating conditions for extended periods may affect device reliability.

ELECTRICAL CHARACTERISTICS

(V_L = +2.7V to +5.5V, BAT = +6V to +26V, \overline{SD} = V_L, T_A = -40°C to +125°C, unless otherwise noted. Typical values are at V_L = +3.3V, BAT = +14V, T_A = +25°C) (Note 1)

PARAMETER	SYMBOL	CONDITIONS	MIN	TYP	MAX	UNITS
POWER SUPPLY						
V _L Supply Range	V _L		2.7		5.5	V
V _L Supply Current	I _L	V _L = +5.5V, V _{BAT} = +14V		0	1	μA
BAT Supply Range	V _{BAT}		6		26	V
Total Supply Current	I _{SUP}	V _L = +5V, V _{BAT} = +14V, continuous scan, programmable hysteresis off, M0 = M1 = 1, WEND = 1, IN0–IN7 = unconnected, \overline{CS} = V _L , SDI = CLK = GND (Note 2)		46	80	μA
Total Supply Current in Scan Mode	I _{SUP_SCAN}	V _{BAT} = +14V, scan mode (SC0 = 0, SC1 = 0, SC2 = 0), \overline{CS} = V _L , SDI = CLK = GND (Note 2)		17	36	μA
Total Supply Current in Shutdown Mode	I _{SHDN}	V \overline{SD} = 0V, V _{BAT} = +14V, V _{BATREF} = +14V (Note 2)	T _A = +25°C	2	3.2	μA
			T _A = -40°C to +125°C	2	4.0	
BATREF Input Leakage Current in Shutdown	I _{L_BATREF}	V \overline{SD} = 0V, V _{BATREF} = +14V			1	μA
BATREF Input Resistance	R _{BATREF}	V _{BATREF} = +14V	1			MΩ
SWITCH INPUTS (IN0–IN7)						
Input-Voltage Threshold Center (Note 3)	V _{TH_C}	R _{HYST} = ∞ or programmable hysteresis disabled	0.425 x V _{BATREF}	0.5 x V _{BATREF}	0.575 x V _{BATREF}	V
		R _{HYST} = 90kΩ	0.4 x V _{BATREF}	0.5 x V _{BATREF}	0.63 x V _{BATREF}	
Input-Voltage Threshold Hysteresis (Note 4)	V _{TH_HYS}	R _{HYST} = ∞ or programmable hysteresis disabled	0.133 x V _{BATREF}	0.166 x V _{BATREF}	0.22 x V _{BATREF}	V
		R _{HYST} = 90kΩ	0.26 x V _{BATREF}	0.361 x V _{BATREF}	0.48 x V _{BATREF}	
		R _{HYST} = 0Ω		0.5 x V _{BATREF}		

Automotive Contact Monitor and Level Shifter

MAX13036

ELECTRICAL CHARACTERISTICS (continued)

($V_L = +2.7V$ to $+5.5V$, $BAT = +6V$ to $+26V$, $\overline{SD} = V_L$, $T_A = -40^\circ C$ to $+125^\circ C$, unless otherwise noted. Typical values are at $V_L = +3.3V$, $BAT = +14V$, $T_A = +25^\circ C$) (Note 1)

PARAMETER	SYMBOL	CONDITIONS	MIN	TYP	MAX	UNITS
Switch-State Sense Resistor	R_{SENSE}		11	16	22	$k\Omega$
Wetting Current Rise/Fall Time	$I_{WET_RISE_FALL}$	$R_{WET} = 61k\Omega$ (Note 5)	Rise	6		μs
			Fall	1		
Wetting Current	I_{WET}	$R_{WET} = 61k\Omega$	22		mA	
		$R_{WET} = 30k\Omega$, $V_{BAT} = 14V$	28	40		51
		$R_{WET} = 330k\Omega$	7.5			
$IN0$ – $IN7$ Input Impedance in Shutdown		$V_{\overline{SD}} = 0V$, $V_{IN_} = +14V$	5.5	8.5		$M\Omega$
LOGIC-LEVELS						
$SD0$, $DO0$, $DO1$ Output Voltage High	V_{OH}	Source current = 2mA	$0.8 \times V_L$			V
$SD0$, $DO0$, $DO1$ Output Voltage Low	V_{OL}	Sink current = 4mA			$0.2 \times V_L$	V
\overline{INT} , \overline{OT} Output Voltage Low	V_{INTL}	Sink current = 4mA			0.4	V
\overline{SD} Input Leakage Current	I_{L_SD}	$V_{\overline{SD}} = V_{BAT} = +12V$	15		30	μA
\overline{SD} Input-Voltage Low	V_{IL_SD}				0.8	V
\overline{SD} Input-Voltage High	V_{IH_SD}		2.4			V
\overline{CS} , CLK, SDI Input-Voltage Low	V_{IL}				$0.33 \times V_L$	V
\overline{CS} , CLK, SDI Input-Voltage High	V_{IH}		$0.66 \times V_L$			V
\overline{CS} , CLK Input Leakage Current	I_{IL}		-1		+1	μA
\overline{INT} , \overline{OT} Leakage Current	I_{OL}		-1		+1	μA
SDI Input Impedance	R_{SDI}		65	100	145	$k\Omega$
THERMAL SHUTDOWN						
Thermal Shutdown Temperature	T_{SHDN}		+170			$^\circ C$
Thermal Shutdown Hysteresis	T_{HYST}		15			$^\circ C$

Automotive Contact Monitor and Level Shifter

TIMING CHARACTERISTICS

($V_L = +2.7V$ to $+5.5V$, $BAT = +6V$ to $+26V$, $\overline{SD} = V_L$, $T_A = -40^\circ C$ to $+125^\circ C$, unless otherwise noted. Typical values are at $V_L = +3.3V$, $BAT = +14V$, $T_A = +25^\circ C$) (Note 1)

PARAMETER	SYMBOL	CONDITIONS	MIN	TYP	MAX	UNITS
IN0 to DO0 Propagation Delay	t _{PROP}	V _{BAT} = 6V		22	35	μs
IN1 to DO1 Propagation Delay		V _{BAT} = +14V		22		
CLK Frequency	f _{CLK}	Input rise/fall time < 2ns, V _L = +3.0V to +5.5V			5	MHz
Falling Edge of \overline{CS} to Rising Edge of CLK Required Setup Time	t _{LEAD}	Input rise/fall time < 2ns, V _L = +3.0V to +5.5V, Figure 1	110			ns
Falling Edge of CLK to Rising Edge of \overline{CS} Required Setup Time	t _{LAG}	Input rise/fall time < 2ns, V _L = +3.0V to +5.5V, Figure 1	50			ns
SDI Valid to Falling Edge of CLK Required Setup Time	t _{SI(SU)}	Input rise/fall time < 2ns, V _L = +3.0V to +5.5V, Figure 1	30			ns
Falling Edge of CLK to SDI Required Hold Time	t _{SI(HOLD)}	Input rise/fall time < 2ns, V _L = +3.0V to +5.5V, Figure 1	20			ns
Time From Falling Edge of \overline{CS} to SDO Low Impedance	t _{SO(EN)}	Input rise/fall time < 2ns, V _L = +3.0V to +5.5V, Figure 1			55	ns
Time From Rising Edge of \overline{CS} to SDO High Impedance	t _{SO(DIS)}	V _L = +3.0V to +5.5V, Figures 1 and 2			55	ns
Time from Rising Edge of CLK to SDO Data Valid	t _{VALID}	C _{SDO} = 15pF, V _L = +3.0V to +5.5V, Figure 1			70	ns
Debounce time	t _{DEB}	C _{TDEB} = 500pF	3.18	5.9	9.42	ms
		C _{TDEB} = 10nF (Note 6)	63	120	188	
Scanning Time Pulse	t _{SCAN}		130	250	400	μs
Scanning Time Period	t _{SCAN_P}	SC2 = 0, SC1 = 1, SC0 = 1	4	8	14	ms
Wetting Time Pulse	t _{WET}	W _{TOFF} = 0	10	21	35	ms
Time from Shutdown To Normal Operation		\overline{SD} low-to-high transition to input monitoring enabled		200		μs

Note 1: All units are 100% production tested at $T_A = +125^\circ C$. Limits over the operating temperature range are guaranteed by correlation to the $+125^\circ C$ tests.

Note 2: The total supply current is the sum of the current flowing into V_L , BAT , and $BATREF$.

Note 3: $V_{TH_C} = (V_{TH_HIGH} + V_{TH_LOW})/2$.

Note 4: $V_{TH_HYS} = (V_{TH_HIGH} - V_{TH_LOW})$.

Note 5: Wetting current rise/fall time is measured as the time from 10% to 90% of the maximum wetting current.

Note 6: Guaranteed by design.

Automotive Contact Monitor and Level Shifter

Test Circuits/Timing Diagrams

MAX13036

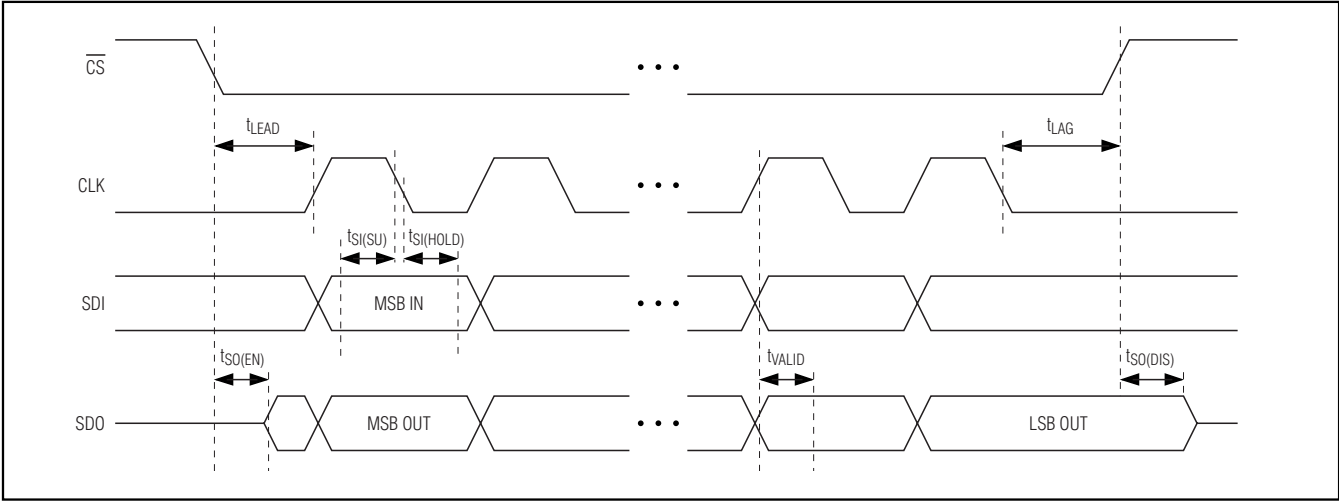

Figure 1. SPI Timing Characteristics

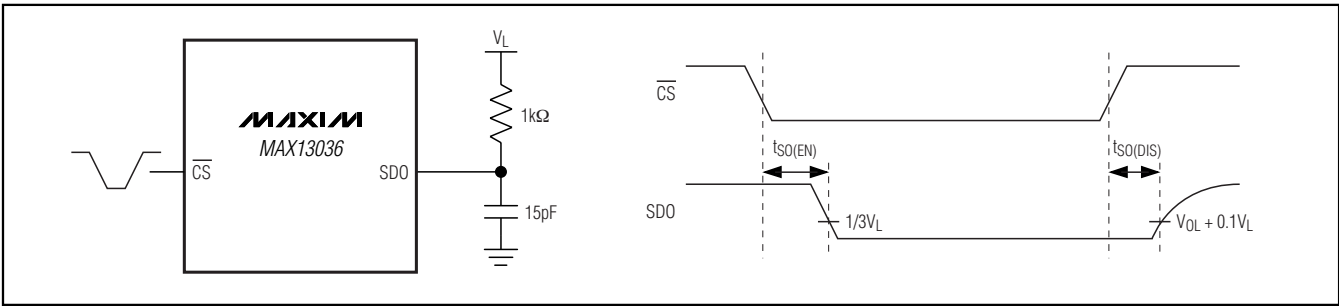
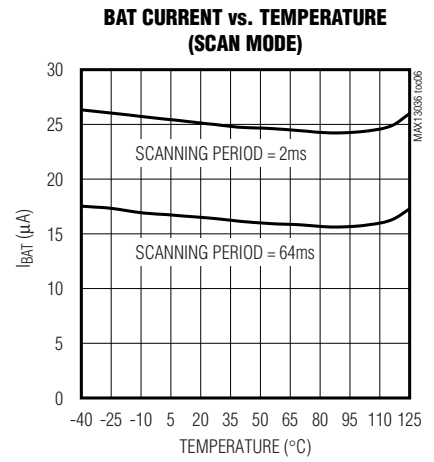
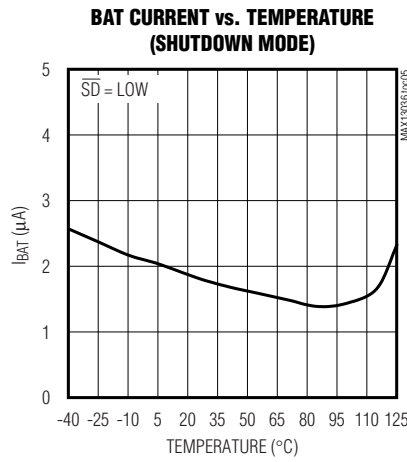
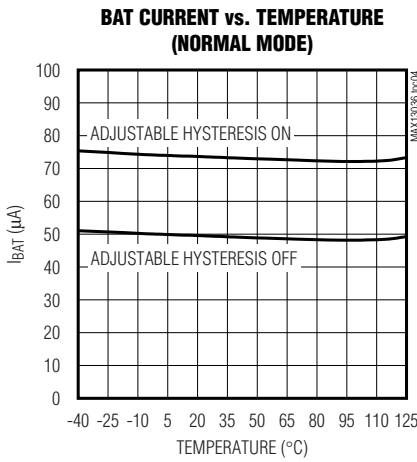
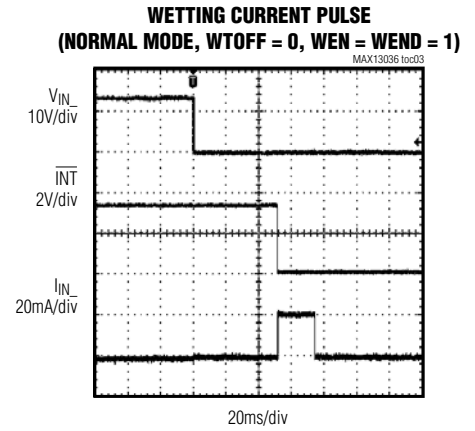
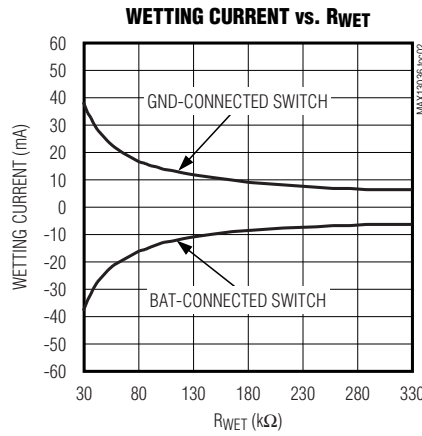
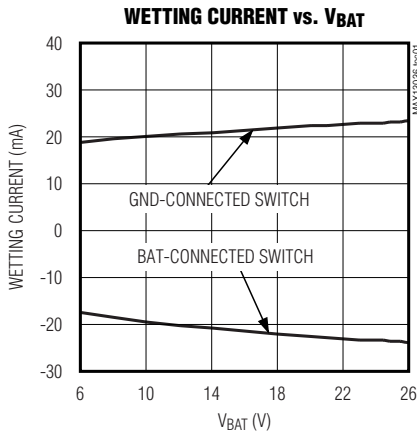

Figure 2. SDO Enable/Disable Test Circuit and Timing Diagram

Automotive Contact Monitor and Level Shifter

Typical Operating Characteristics

($V_L = +3.3V$, $BAT = +14V$, $\overline{SD} = V_L$, $R_{WET} = 61k\Omega$, $R_{HYST} = 90k\Omega$, $C_{TDEB} = 4700pF$, $T_A = +25^\circ C$, unless otherwise noted.)



TYPICAL I_{NO} DRIVING (NORMAL MODE, $WTOFF = WEN = WEND = 0$)

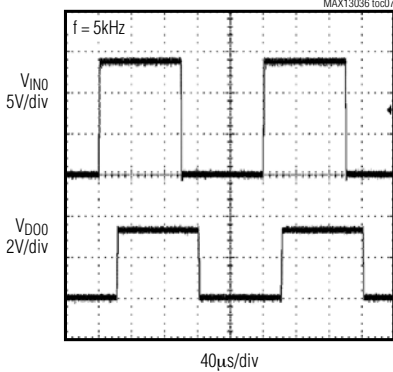

TYPICAL I_{NO} DRIVING (NORMAL MODE, $WTOFF = WEN = WEND = 0$)

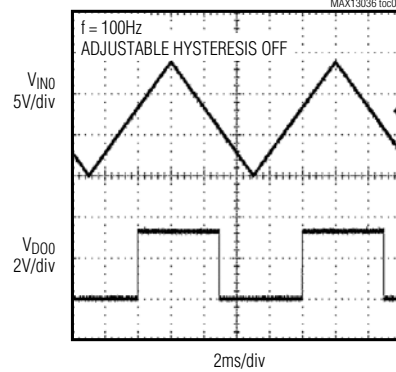

HYSTERESIS vs. R_{HYST}

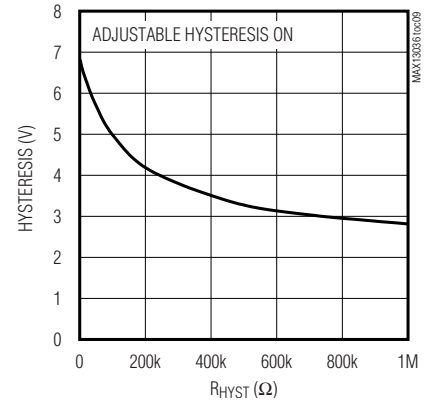

Automotive Contact Monitor and Level Shifter

MAX13036

Typical Operating Characteristics (continued)

($V_L = +3.3V$, $BAT = +14V$, $\overline{SD} = V_L$, $R_{WET} = 61k\Omega$, $R_{HYST} = 90k\Omega$, $C_{TDEB} = 4700pF$, $T_A = +25^\circ C$, unless otherwise noted.)

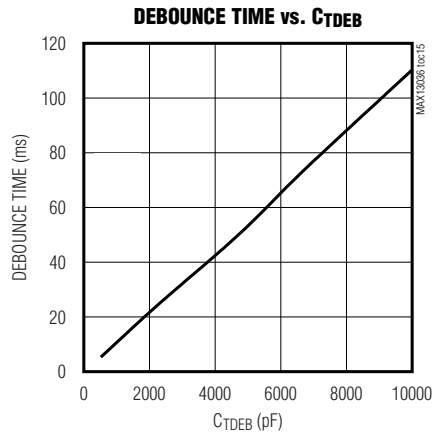
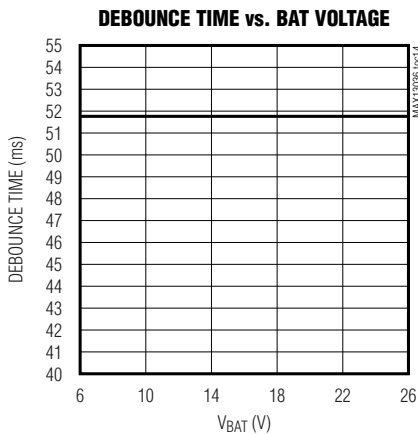
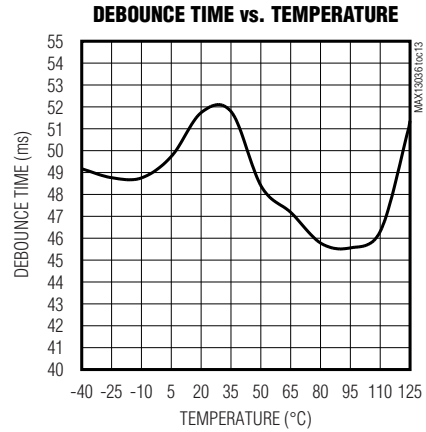
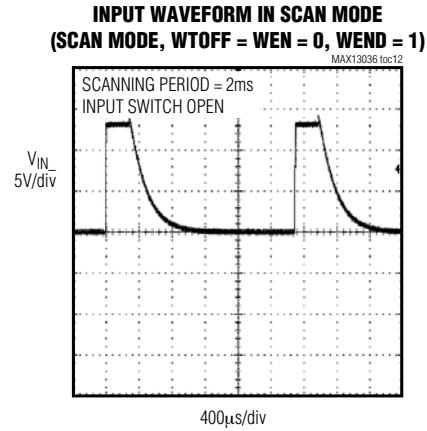
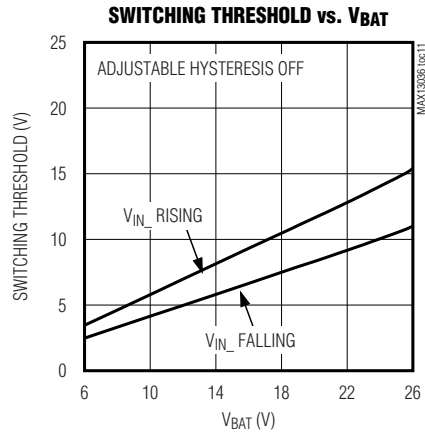
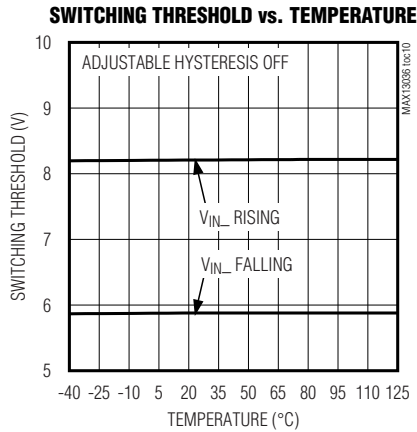

Automotive Contact Monitor and Level Shifter

Pin Description

PIN	NAME	FUNCTION
1	IN1	Switch Input Channel 1. Connect IN1 to a switch connected to GND. IN1 can be programmed as a direct input with a level-shifted output on DO1 (see the <i>Mechanical Switch Inputs (IN0–IN7)</i> section).
2	IN2	Switch Input Channel 2. Connect IN2 to a switch connected to GND.
3	IN3	Switch Input Channel 3. Connect IN3 to a switch connected to GND.
4	IN4	Switch Input Channel 4. Connect IN4 to a switch connected to GND or BAT.
5	IN5	Switch Input Channel 5. Connect IN5 to a switch connected to GND or BAT.
6	IN6	Switch Input Channel 6. Connect IN6 to a switch connected to GND or BAT.
7	IN7	Switch Input Channel 7. Connect IN7 to a switch connected to GND or BAT.
8, 20, 27	N.C.	No Connection. Not internally connected.
9	HYST	Hysteresis Input. Connect HYST to GND with a 0 to 900kΩ resistor to set the input voltage hysteresis on IN0–IN7.
10	WET	Wetting Current Input. Connect a 30kΩ to 330kΩ resistor from WET to GND to set the wetting current on IN0–IN7.
11	TDEB	Switch Debounce Time Input. Connect a 500pF to 10nF capacitor from TDEB to GND to set the switch debounce time.
12, 24	GND	Ground
13	\overline{OT}	Overtemperature Warning Output. \overline{OT} is an open-drain output that asserts low when the thermal warning threshold is exceeded.
14	\overline{INT}	Interrupt Output. \overline{INT} is an open-drain output that asserts low when one or more of the IN0–IN7 inputs change state and is enabled for interrupts.
15	\overline{CS}	SPI Chip-Select Input. Drive \overline{CS} low to enable clocking of data into and out of the MAX13036. SPI data is latched into the MAX13036 on the rising edge of \overline{CS} .
16	SDO	SPI Serial Data Output. SPI data is output on SDO on the rising edges of CLK while \overline{CS} is held low. SDO is tri-stated when \overline{CS} is high.
17	SDI	SPI Serial Data Input. SPI data is latched into the internal shift register on the falling edges of CLK while \overline{CS} is held low. SDI has an internal 100kΩ pulldown resistor.
18	CLK	SPI Serial Clock Input
19	V_L	Logic Power-Supply Input. Connect V_L to a positive 2.7V to 5.5V power supply. Bypass V_L to ground with a 0.1μF capacitor placed as close as possible to V_L .
21	DO1	Data Output Channel 1. DO1 is the level-shifted output of IN1 when WEND = 0 (normal mode only).
22	DO0	Data Output Channel 0. DO0 is the level-shifted output of IN0 when WEND = 0 (normal mode only).
23	\overline{SD}	Shutdown Input. Drive \overline{SD} low to place the MAX13036 into shutdown mode. Drive \overline{SD} high for normal operation. \overline{SD} is compatible with voltages up to +45V.
25	BATREF	Battery Reference Input. Switch thresholds are set to 50% of the voltage applied to BATREF. Connect BATREF to the system's battery supply voltage.
26	BAT	Battery Supply Input. Connect BAT to a positive 6V to 26V battery supply voltage. Bypass BAT to ground with a 0.1μF ceramic capacitor placed as close as possible to BAT. In addition, bypass BAT with a 10μF or greater capacitor.
28	IN0	Switch Input Channel 0. Connect IN0 to a switch connected to GND. IN0 can be programmed as a direct input with a level-shifted output on DO0 (see <i>Mechanical Switch Inputs (IN0–IN7)</i> section).
—	EP	Exposed Paddle. Connect EP to GND.

Automotive Contact Monitor and Level Shifter

Functional Diagram

MAX13036

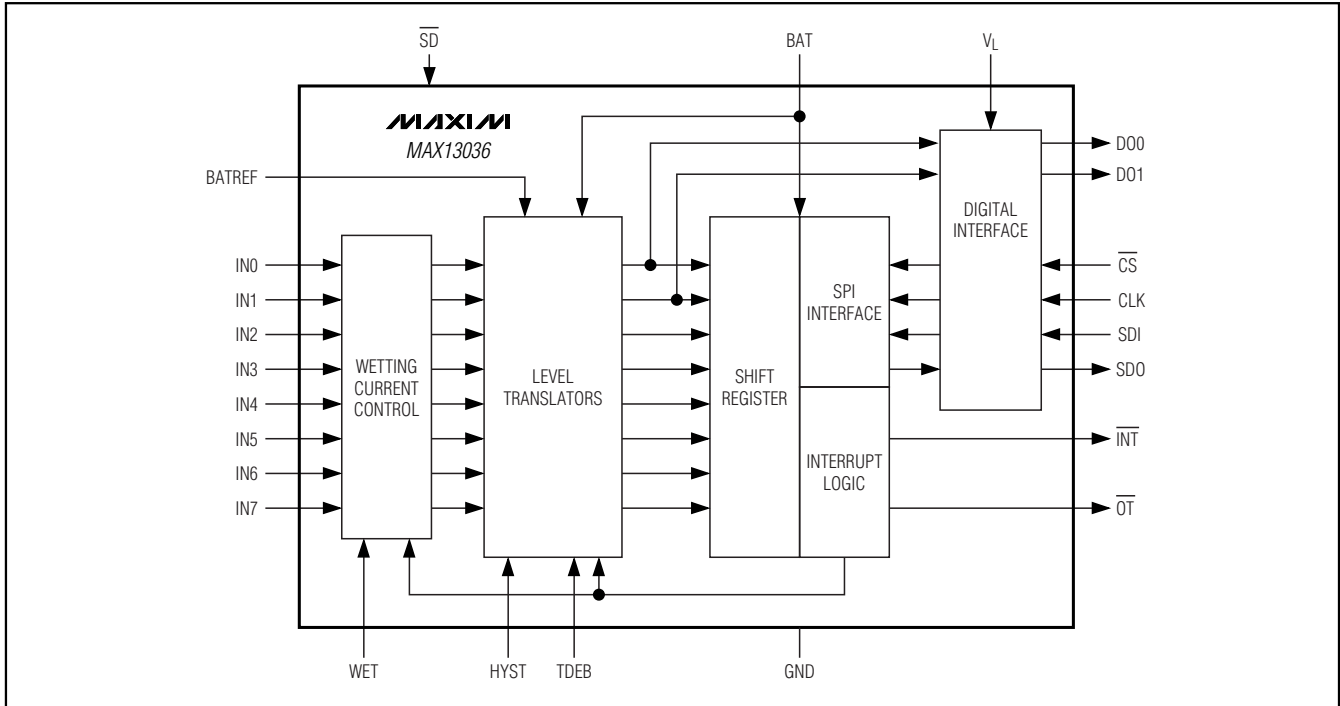

Detailed Description

The MAX13036 automotive contact monitor and level shifter monitors and debounces eight remote mechanical switches and asserts an interrupt (\overline{INT}) if a switch changes state. Any of the switch inputs can be prohibited from asserting an interrupt. The switch threshold levels are set to 50% of the voltage applied to BATREF. All switch inputs feature a common adjustable hysteresis, debounce time and wetting current. Two switch inputs (IN0, IN1) are programmable to have direct outputs (DO0, DO1) useable for PWM or other timing based signals.

The MAX13036 features an SPI interface to monitor individual switch inputs and to configure interrupt masking, hysteresis and wetting current enable/disable, switch configuration (battery connected or ground connected), and scanning period.

The MAX13036 features three modes of operation: normal mode, scan mode, and shutdown mode. In normal mode, the part is fully functional and sensing resistors are connected to all switch inputs. In scan mode, the sensing resistors are connected for a finite duration to reduce power consumption. In shutdown mode, all switch inputs are high impedance to further reduce power consumption.

VL

V_L is the power-supply input for the digital input/output buffers. The SPI interface (\overline{CS} , CLK, SDI, SDO), and digital outputs (DO0, DO1) are referenced to the voltage on V_L . Connect V_L to the system's +2.7V to +5.5V logic-level supply. Bypass V_L to ground with a 0.1 μ F capacitor placed as close as possible to the device.

BAT

BAT is the main power-supply input. Bypass BAT to ground with a 0.1 μ F ceramic capacitor placed as close as possible to BAT. In addition, bypass BAT with a 10 μ F or greater capacitor. BAT can withstand DC voltages up to +42V.

Mechanical Switch Inputs (IN0-IN7)

IN0 through IN7 are the inputs for remote mechanical switches. The status of each switch input is indicated by the SW0 through SW7 bits in the status register, and each switch input can be programmed to not assert an interrupt (\overline{INT}) by writing to the P0 through P7 bits in the command register. All switch inputs are configured to assert an interrupt upon power-up.

Automotive Contact Monitor and Level Shifter

The first four inputs (IN0–IN3) are intended for ground-connected switches. The remaining four inputs (IN4–IN7) can be programmed in sets of two for either ground-connected or battery-connected switches by writing to the M0 and M1 bits (see Table 5). The default state after power-up is IN2–IN7 configured for ground-connected switches, and IN0/IN1 configured for direct inputs.

All switch inputs have internal 16kΩ sense resistors to detect switch transitions. Inputs configured for ground-connected switches are pulled up to BAT and inputs configured for battery-connected switches are pulled down to GND. Figure 3 shows the switch input structure for IN0 and IN1. IN0 and IN1 can be programmed as direct inputs with level-shifted outputs (DO0 and DO1) by clearing the WEND bit in the command register (normal mode only). When programmed as direct inputs, IN0 and IN1 can be used for PWM or other signaling. Clearing the WEND bit disables the sense resistors and wetting currents on IN0 and IN1. When programmed as direct inputs, the status of IN0 and IN1 is not reflected in the status register, and interrupts are not allowed on these inputs.

Switch Threshold Levels and Hysteresis (BATREF, HYST)

Input thresholds for the remote switches are 50% of the voltage applied to BATREF. The BATREF input is typically connected to the battery voltage before the

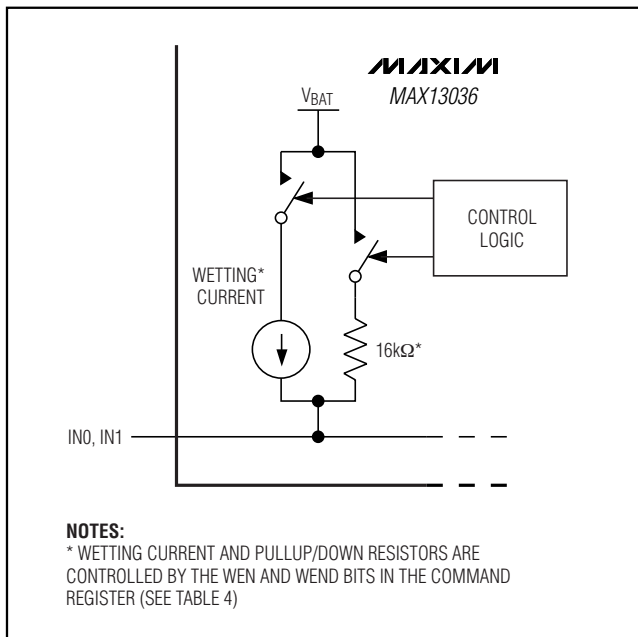

Figure 3. Input Structure of IN0 and IN1

reverse-battery protection diode. The MAX13036 features adjustable hysteresis on the switch inputs by connecting an external 0 to 900kΩ resistor from HYST to ground (normal mode only). Short HYST to ground to obtain the maximum hysteresis of (0.5 × V_{BATREF}). The approximate formula for hysteresis is given below:

$$V_{\text{HYST}} = \left[0.166 + \frac{43}{(123 + (R_{\text{HYST}}(\text{k}\Omega)))} \right] (V_{\text{BATREF}})$$

To reduce power consumption, the adjustable hysteresis can be disabled by setting [SC2:SC1:SC0 = 1:1:0] in the command register. When the adjustable hysteresis is disabled, the hysteresis is set to 0.166 × V_{BATREF}.

Switch Debounce and Deglitch

The switch inputs IN0–IN7 share a common programmable debounce timer to increase the noise immunity of the system in normal and scan mode. The switch debounce time is set by connecting a capacitor between the t_{DEB} input and ground. The minimum value of this capacitor is 500pF and the maximum value is 10nF, corresponding to a debounce time of 5ms to 100ms respectively. To calculate other debounce times the following formula should be used:

$$C(\text{nF}) = t_{\text{DEB}}(\text{ms})/10$$

All switch input glitches of less than 20μs in duration are automatically rejected by the MAX13036.

Debounce in Normal Mode

When a change of state occurs at the switch input the debounce timer starts. If the new state is stable for at least t_{DEB}, the status register is updated and an interrupt is generated (if enabled). If the input returns to its previous state before the debounce time has elapsed, an interrupt is not generated and the status register is not updated.

Debounce in Scan Mode

A change of state at the switch input causes the device to automatically enter normal mode and the debounce timing to start. The device remains in normal mode as long as the input state differs from the previous state. As soon as the debounce time ends, the status register is updated, an interrupt is generated, and the device re-enters scan mode.

If the input returns to its previous state before the end of the debounce time, the device re-enters scan mode, an interrupt is not generated, and the status register is not updated.

Automotive Contact Monitor and Level Shifter

Wetting Current (WET)

The MAX13036 features adjustable wetting current to any closed switch to clean switch contacts that are exposed to adverse conditions. The wetting current is set by connecting a 30k Ω to 330k Ω resistor from WET to ground. A 30k Ω resistor corresponds to a wetting current of 40mA (typ) and a 330k Ω resistor corresponds to a 7.5mA (typ) wetting current. See the *Typical Operating Characteristics* section for the relationship between the wetting current and R_{WET}.

The WEN and WEND bits in the command register enable and disable the wetting currents and the WTOFF bit allows the wetting current to be activated for a duration of 20ms (typ) (see the *Command Register* section). Disabling wetting currents, or limiting the active wetting current time reduces power consumption. The default state upon power-up is all wetting currents disabled.

Wetting current is activated on closed switches just after the debounce time. The wetting current pulse starts after the debounce time. A wetting current pulse is provided to all closed switches when a valid input change is detected. Wetting current rise and fall times are controlled to enhance EMC performance. There is one wetting current timer for all switch inputs. Therefore, it is possible to observe wetting pulses longer than expected whenever two switches turn on in sequence and are spaced out less than t_{WET}. In scan mode, the wetting current is enabled during the polling pulse only.

When using wetting currents, special care must be taken to avoid exceeding the maximum power dissipation of the MAX13036 (see the *Applications Information* section).

Switch Outputs (DO0, DO1)

DO0 and DO1 are direct level-shifted outputs of the switch inputs IN0 and IN1 when the WEND bit of the command register is cleared and when operating in normal mode. When configured as direct inputs, the wetting currents and sensing resistors are disabled on IN0 and IN1. DO0 and DO1 are tri-stated when the WEND bit is set or when operating in scan mode.

When programmed as direct inputs, the status of IN0 and IN1 are not reflected in the status register and interrupts are not allowed on these inputs.

Interrupt Output ($\overline{\text{INT}}$)

$\overline{\text{INT}}$ is an active-low, open-drain output that asserts when any of the switch inputs changes state, as long as the particular input is enabled for interrupts (set by clearing P7–P0 in the command register). A pullup resistor to V_L is needed on $\overline{\text{INT}}$. $\overline{\text{INT}}$ is cleared when $\overline{\text{CS}}$ is driven low for a read/write operation.

The $\overline{\text{INT}}$ output will still assert when V_L is absent provided that it is pulled up to a different supply voltage.

Thermal Protection ($\overline{\text{OT}}$)

The MAX13036 features thermal protection that prevents the device from being damaged by overheating. When the internal temperature of the device exceeds the thermal warning threshold of +170°C (typ), all wetting currents are disabled. The MAX13036 returns to normal operation after the internal temperature decreases below +155°C (typ). The thermal shutdown does not activate below +150°C. The thermal protection feature is disabled when WEN = 0 or when all inputs are open.

An open-drain, active-low output ($\overline{\text{OT}}$) asserts low when the internal temperature of the device rises above the thermal warning threshold. $\overline{\text{OT}}$ is immediately cleared when the $\overline{\text{CS}}$ input is driven low for write/read operations, regardless of whether the temperature is above the threshold or not. The overtemperature status of the MAX13036 can also be monitored by reading the OT bit in the status register. The OT bit is set when the internal temperature rises above the temperature threshold and it is cleared when the temperature falls below the temperature hysteresis level. This allows a microprocessor (μP) to monitor the overtemperature status, even if the $\overline{\text{OT}}$ output has been cleared. See Figure 4 for an example timing diagram of the overtemperature alerts.

If desired, the $\overline{\text{OT}}$ and $\overline{\text{INT}}$ outputs can be connected to the same μP GPIO in a wired-OR configuration to save a μP pin. The $\overline{\text{OT}}$ output still asserts when V_L is absent provided that it is pulled up to a different supply voltage.

Serial Peripheral Interface ($\overline{\text{CS}}$, SDO, SDI, CLK)

The MAX13036 operates as a Serial Peripheral Interface (SPI) slave device. An SPI master accesses the MAX13036 by reading from a status register and writing to a command register. Both registers are 16 bits long and are accessed most significant bit (MSB) first.

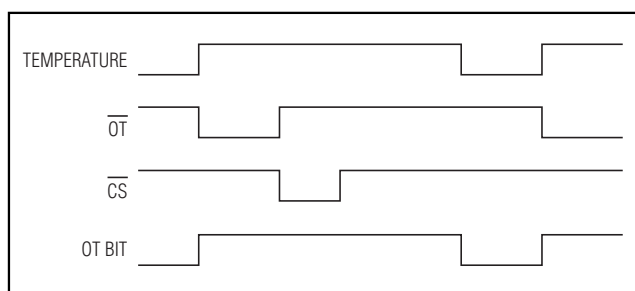

Figure 4. Example Timing Diagram of the Overtemperature Alerts

Automotive Contact Monitor and Level Shifter

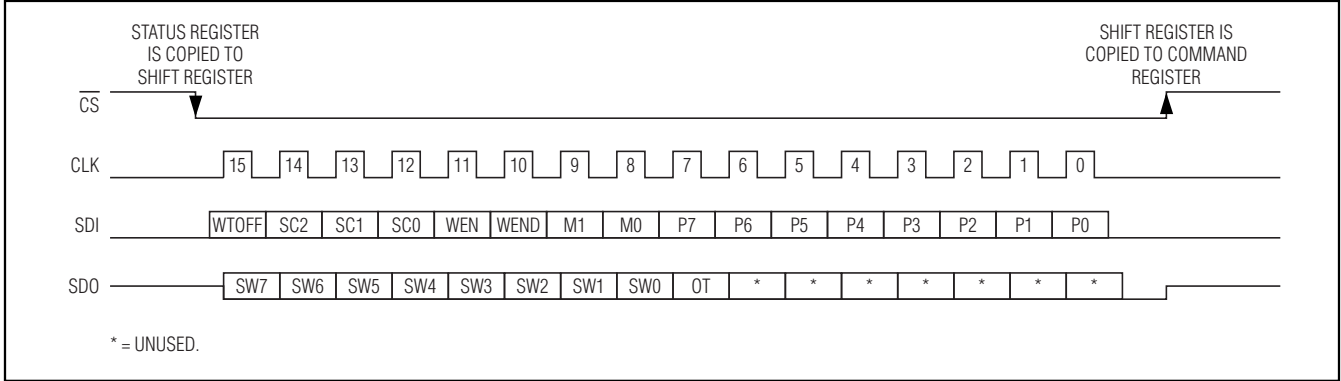

Figure 5. SPI Read/Write Example

On the falling edge of \overline{CS} , the status register is immediately loaded to an internal shift register and the contents are transferred out of the SDO output on the rising edge of CLK. Serial data on the SDI input is latched into the shift register on the falling edge of CLK. On the rising edge of \overline{CS} , the contents of the shift register are copied to the command register (see Figure 5). The status and command registers are 16 bits wide, so it is essential to clock a total of 16 bits while \overline{CS} is low for the input and output data to be valid. When \overline{CS} is high, the SDO output is high-impedance and any transitions on CLK and SDI are ignored. The \overline{INT} and \overline{OT} flags are cleared on the \overline{CS} falling edge. Input status changes occurring during the \overline{CS} reading/writing operation are allowed. If a switch status changes when \overline{CS} is low, the interrupt is asserted as usual. This allows the part to be used even if V_L is absent provided that the \overline{INT} output is pulled up to another supply voltage.

Status Register

The status register contains the status of the switches connected to IN7 through IN0 and it also contains an overtemperature warning bit (see Table 1). The status register is accessed through an SPI-compatible master.

Table 1. Status Register

BIT	15	14	13	12	11	10	9	8	7	6	5	4	3	2	1	0
NAME	SW7	SW6	SW5	SW4	SW3	SW2	SW1	SW0	OT	—	—	—	—	—	—	—

Table 2. Command Register

BIT	15	14	13	12	11	10	9	8	7	6	5	4	3	2	1	0
NAME	WTOFF	SC2	SC1	SC0	WEN	WEND	M1	M0	P7	P6	P5	P4	P3	P2	P1	P0
POR	0	0	0	0	0	0	0	0	0	0	0	0	0	0	0	0

Notes:

Bits 15–8: Switch 7 Through 0 Status (SW7–SW0)

SW7 through SW0 reflect the status of the switches connected to inputs IN7 through IN0, respectively. Open switches are returned as a [0] and closed switches are returned as a [1].

Bit 7: Overtemperature Warning (OT)

The OT bit returns a [1] when the internal temperature of the MAX13036 is above the temperature warning threshold of +170°C (typ). The OT bit returns a [0] when the MAX13036 is either below the temperature threshold, or it has fallen below the temperature hysteresis level following an overtemperature event.

Bits 6–0: Unused

Bits 6 through 0 are unused and should be ignored.

Command Register

The command register is used to configure the MAX13036 for various modes of operation and is accessed by an SPI-compatible master (see Table 2). The power-on reset (POR) value of the command register is 0x00.

Automotive Contact Monitor and Level Shifter

Notes:

Bit 15: Wetting Current Mode (WTOFF)

Set the WTOFF bit to configure the wetting currents as continuous on closed switches. Clear the WTOFF bit to configure the wetting current as a pulse where the wetting current is turned on for a set duration of 20ms after a switch closes (and the debounce is timed out). After 20ms elapses, the wetting current is turned off. Either wetting current mode is only applicable to switches that have wetting currents enabled (see WEN and WEND bits). In scan mode, the wetting currents are on for the polling time of 250µs (typ) and are pulsed at the programmed scanning period. When WTOFF is set, the wetting current continuously pulses at the programmed scanning period. When WTOFF is cleared, the wetting current pulses at the programmed scanning period, but turns off after 20ms elapses.

Bits 14, 13, 12: Scanning Period (SC2, SC1, SC0)

The SC2, SC1, and SC0 bits are used to program the scanning period as depicted in Table 3. Switch inputs are simultaneously polled for a finite duration of 250µs (typ) and polling occurs at a period selected through the SC2, SC1, and SC0 inputs. Figure 6 shows a timing diagram of switch scanning and sampling. When the inputs are not being polled, the sense resistors are disconnected, reducing the current consumption caused from polling closed switches. For a continuous scan-

ning period ([SC2:SC1:SC0] = [1:1:1] or [1:1:0]), the switch inputs are constantly being monitored and the sense resistors are always connected. The state [SC2:SC1:SC0] = [1:1:0] also disables adjustable hysteresis (normally set by RHYST) and fixes hysteresis at 0.166 x VBATREF. When adjustable hysteresis is not needed, it is recommended to disable this feature to reduce power consumption.

Bit 11: Global Wetting Current Enable (WEN)

The WEN bit is a global enable for the wetting currents on all the channels. Set the WEN bit to enable wetting currents on all channels and clear the WEN bit to disable wetting currents. Even with wetting currents globally enabled, the wetting currents and sense resistors on IN0 and IN1 can still be turned off with the WEND bit (see Table 4).

Bit 10: IN0 and IN1 Wetting Current Enable (WEND)

The WEND bit is used to turn on wetting currents and sense resistors on inputs IN0 and IN1. Set the WEND bit to enable wetting currents on IN0 and IN1 and clear the WEND bit to turn off the wetting current and sense resistors on IN0 and IN1. When the wetting currents and sense resistors are disabled (WEND = 0), IN0 and IN1 are configured as direct inputs with level-shifted outputs on DO0 and DO1. DO0 and DO1 can only be used as level-shifted outputs in normal mode and are tri-stated in scan mode (see the *Scan Mode* section). Note that both the WEN and WEND bits need to be set for wetting currents to be enabled on IN0 and IN1 (see

Table 3. Programmable Scanning Period

SC2	SC1	SC0	SCANNING PERIOD (ms)
0	0	0	64
0	0	1	32
0	1	0	16
0	1	1	8
1	0	0	4
1	0	1	2
1	1	0	Continuous / Adjustable Hysteresis Off
1	1	1	Continuous

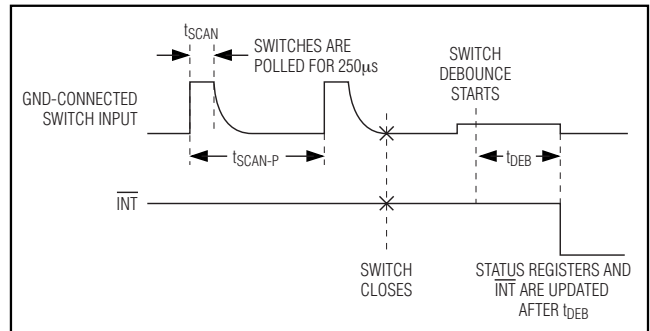

Figure 6. Switch Sampling in Scan Mode

Table 4. Truth Table for WEN and WEND

WEN	WEND	WETTING CURRENT (IN0, IN1)	16kΩ SENSE RESISTOR (IN0, IN1)	WETTING CURRENT (IN2–IN7)	16kΩ SENSE RESISTOR (IN2–IN7)
0	0	Off	Off	Off	On
0	1	Off	On	Off	On
1	0	Off	Off	On	On
1	1	On	On	On	On

Automotive Contact Monitor and Level Shifter

Table 5. Switch Configuration Controlled by M1 and M0

M1	M0	IN7 AND IN6 SWITCH CONFIGURATION	IN5 AND IN4 SWITCH CONFIGURATION	IN3–IN0 SWITCH CONFIGURATION
0	0	Ground	Ground	Ground
0	1	Ground	Battery	Ground
1	0	Battery	Ground	Ground
1	1	Battery	Battery	Ground

Table 4). The DO0 and DO1 outputs are tri-stated when WEND = 1. When programmed as direct inputs (WEND = 0), any input changes on IN0 and IN1 are not reflected by the status register.

Bits 9 and 8: Switch Configuration for IN7–IN4 (M1, M0)

The M1 and M0 bits set the switch configuration in groups of two for IN7 through IN4 (see Table 5). Set M1 to configure IN7 and IN6 for battery-connected switches and clear M1 for ground-connected switches. Set M0 to configure IN5 and IN4 for battery-connected switches and clear M0 for ground-connected switches.

Bits 7–0: Interrupt Enable for IN7–IN0 (P7–P0)

The P7 through P0 bits allow independent control of whether inputs IN7 through IN0 generate an interrupt (INT). Set any bit to disable interrupts on the corresponding input and clear the bit to enable interrupts on the corresponding channel. An interrupt is asserted when any input configured for interrupts changes state. IN0 and IN1 do not generate an interrupt when configured as direct inputs (WEND = 0).

Operating Modes

The MAX13036 features three modes of operation: normal mode, scan mode, and shutdown mode. Normal mode is entered when the scanning period bits in the command register are configured for continuous scanning ([SC2:SC1:SC0] = [1:1:1] or [1:1:0]). Scan mode is entered when the scanning period bits are set for a periodic scanning time as shown in Table 3. Shutdown mode is entered by driving the shutdown input (\overline{SD}) low. The default mode after power-up is scan mode (when \overline{SD} = high) with a scan period of 64ms.

Normal Mode (Continuous Scanning)

In normal mode, the input sense resistors are always connected to the switch inputs to detect any input status change (except IN0 and IN1 when WEND = [0]). Wetting currents are enabled according to the WEN, WEND and WTOFF bits in the command register. If adjustable hysteresis is not required, this feature can be disabled to reduce power consumption (see the *Typical Operating Characteristics*) by setting the scanning period bits in the

command register to ([SC2:SC1:SC0] = [1:1:0]). The hysteresis is set to $0.166 \times V_{BATREF}$ when adjustable hysteresis is disabled.

Scan Mode

In scan mode, each sense resistor is connected for a finite duration of 250 μ s (typ) and is repeated at a period according to the scanning period bits SC2, SC1, and SC0 (see Table 3). All input resistors are connected simultaneously and the inputs are polled at the same time. Scan mode reduces the current consumption from BAT to 17 μ A (typ) when all external switches are open and the scanning period is 64ms. Wetting currents (if enabled) are applied to closed switches during the polling time of 250 μ s (typ) and are pulsed at the programmed scanning period. When WTOFF is set, the wetting current continuously pulses at the programmed scanning period. When WTOFF is cleared, the wetting current pulses at the programmed scanning period, but turns off after 20ms elapses. Inputs IN0 and IN1 cannot be used as direct inputs (WEND = 0) in scan mode. When configured as direct inputs in scan mode, the outputs DO0 and DO1 are high impedance. The quiescent current for a given scan mode can be calculated by the following formula:

$$I_{BAT(\mu A)} = 16 \times \left(1 + \frac{1}{t_{SCAN_P(ms)}} \right)$$

Where \overline{SD} = 3.3V, I_{BAT} is the BAT current expressed in microamps and t_{SCAN_P} is the scanning period expressed in milliseconds.

Shutdown Mode

In shutdown mode, all switch inputs are high impedance and the external switches are no longer monitored, reducing current consumption on BAT to 2 μ A (typ). The MAX13036 resets upon entering shutdown mode and the contents of the command register are lost. Exit shutdown mode by bringing the voltage on \overline{SD} above +2.4V. The \overline{SD} input is compatible with voltages up to V_{BAT} . The MAX13036 takes 200 μ s (typ) to exit shutdown, at which point the command register is restored to its power-up

Automotive Contact Monitor and Level Shifter

default (0x00) and the MAX13036 enters scan mode. Note that \overline{SD} is compatible with both V_L and BAT voltage levels. Having \overline{SD} compatible to V_{BAT} allows the MAX13036 to retain the settings in the command register as well as input monitoring even when V_L is missing, provided that $\overline{SD} = V_{BAT}$. To reduce current consumption, connect \overline{SD} to BAT through a 470k Ω resistor. Having \overline{SD} compatible with V_L has the advantage of reducing input leakage current into \overline{SD} when $\overline{SD} = V_L$.

Applications Information

Automotive Considerations

Reverse-Battery Tolerance

The BATREF and IN0–IN7 inputs withstand voltages down to -45V without damage so that reverse battery is not an issue. The BAT pin should be protected with a reverse-battery diode as shown in the *Typical Application Circuit*. The shutdown input (\overline{SD}) can be controlled from a battery-level source but should be protected against reverse battery in the application.

Wetting Currents and Power Dissipation

It is important to consider the effects of wetting currents on the power dissipated by the MAX13036. For example, assume all inputs are configured for a continuous wetting current of 25mA, all external switches have an on-resistance of 1 Ω and the battery voltage is 16V. If all switches are simultaneously closed, the corresponding power dissipated by the MAX13036 is $(16V - (25mA \times 1\Omega)) \times 25mA \times 8 = 3.12W$; this is higher than the absolute maximum power dissipation of 2759mW at $T_A = +70^\circ C$.

ESD Protection

As with all Maxim devices, ESD-protection structures are incorporated on all pins to protect against electrostatic discharges encountered during handling and assembly. The IN7–IN0 inputs have extra protection against static electricity. Maxim's engineers have developed state-of-the-art structures to protect these pins against ESD of $\pm 8kV$ without damage.

Human Body Model

The MAX13036 IN7–IN0 pins are characterized for $\pm 8kV$ ESD protection using the Human Body Model. Figure 7a shows the Human Body Model and Figure 7b shows the current waveform it generates when discharged into a low impedance. This model consists of a 100pF capacitor charged to the ESD voltage of interest, which is then discharged into the device through a 1.5k Ω resistor.

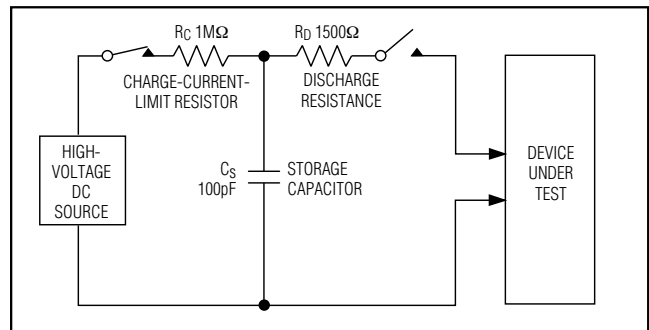

Figure 7a. Human Body ESD Test Model

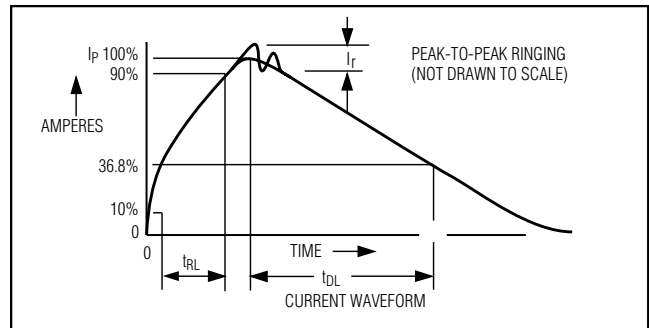

Figure 7b. Human Body Model Current Waveform

Chip Information

PROCESS: BiCMOS

Automotive Contact Monitor and Level Shifter

Typical Application Circuit

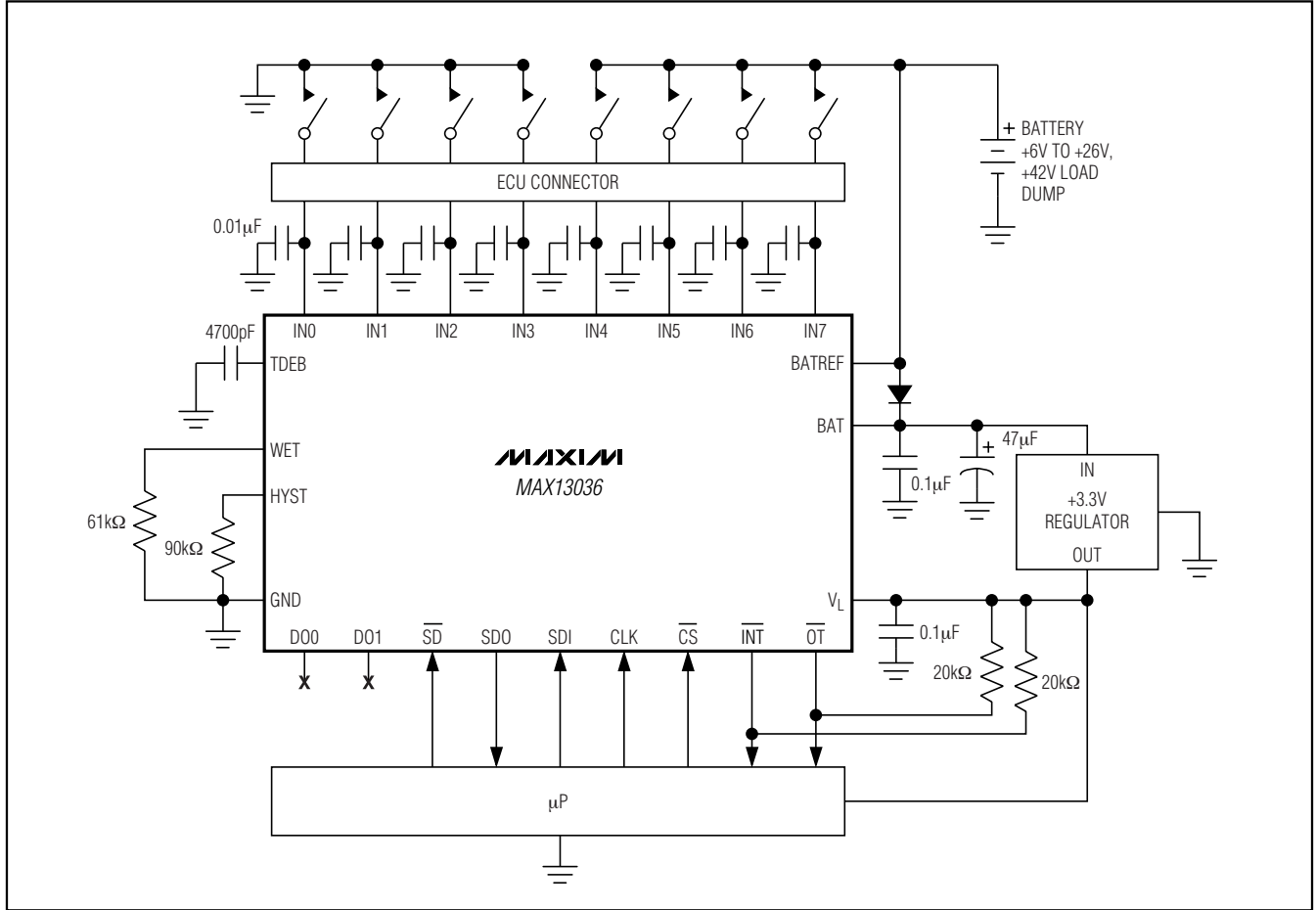

Automotive Contact Monitor and Level Shifter

Package Information

(The package drawing(s) in this data sheet may not reflect the most current specifications. For the latest package outline information, go to www.maxim-ic.com/packages.)

MAX13036

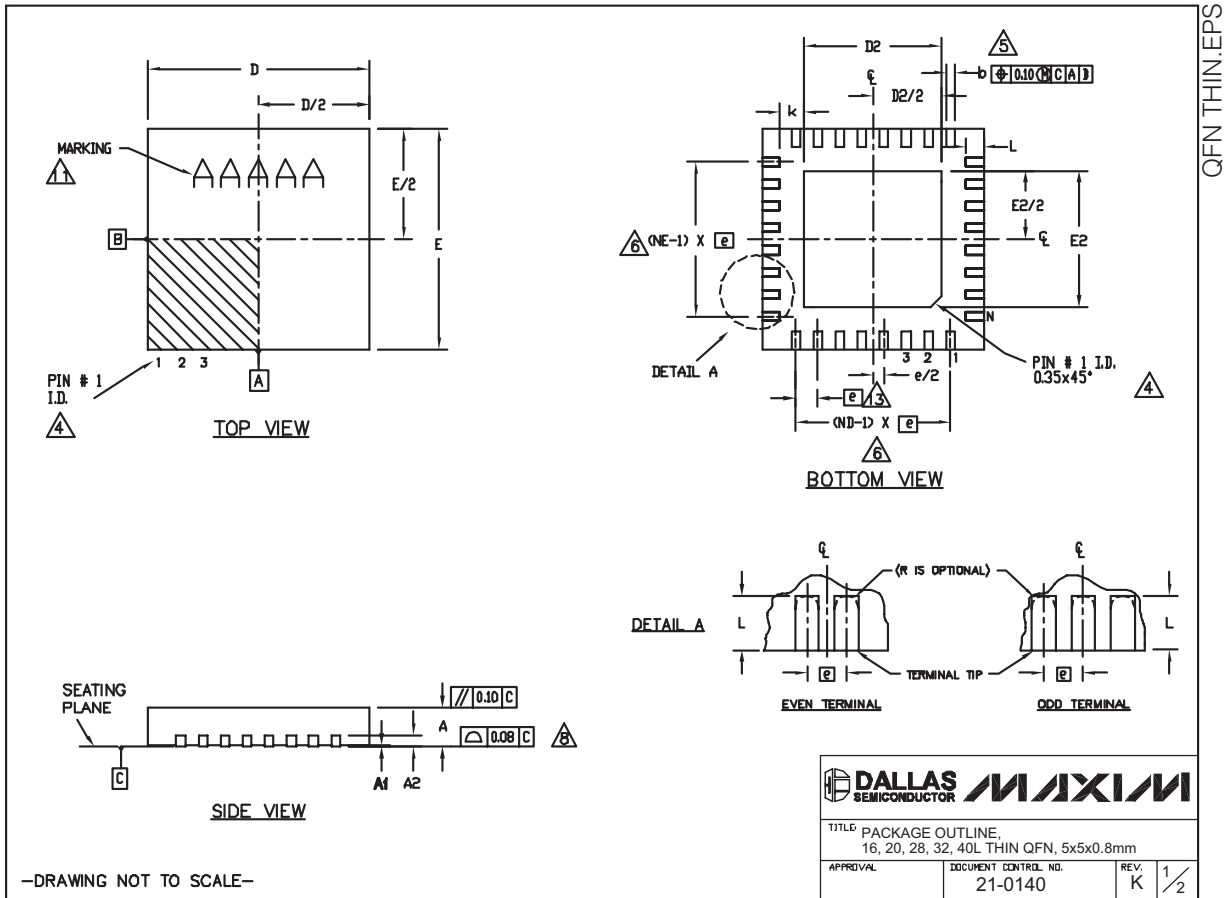

Automotive Contact Monitor and Level Shifter

Package Information (continued)

(The package drawing(s) in this data sheet may not reflect the most current specifications. For the latest package outline information, go to www.maxim-ic.com/packages.)

COMMON DIMENSIONS															
PKG. SYMBOL	16L 5x5			20L 5x5			28L 5x5			32L 5x5			40L 5x5		
	MIN.	NOM.	MAX.	MIN.	NOM.	MAX.	MIN.	NOM.	MAX.	MIN.	NOM.	MAX.	MIN.	NOM.	MAX.
A	0.70	0.75	0.80	0.70	0.75	0.80	0.70	0.75	0.80	0.70	0.75	0.80	0.70	0.75	0.80
A1	0	0.02	0.05	0	0.02	0.05	0	0.02	0.05	0	0.02	0.05	0	0.02	0.05
A2	0.20 REF.			0.20 REF.			0.20 REF.			0.20 REF.			0.20 REF.		
b	0.25	0.30	0.35	0.25	0.30	0.35	0.20	0.25	0.30	0.20	0.25	0.30	0.15	0.20	0.25
D	4.90	5.00	5.10	4.90	5.00	5.10	4.90	5.00	5.10	4.90	5.00	5.10	4.90	5.00	5.10
E	4.90	5.00	5.10	4.90	5.00	5.10	4.90	5.00	5.10	4.90	5.00	5.10	4.90	5.00	5.10
e	0.80 BSC.			0.65 BSC.			0.50 BSC.			0.50 BSC.			0.40 BSC.		
k	0.25	-	-	0.25	-	-	0.25	-	-	0.25	-	-	0.25	-	-
L	0.30	0.40	0.50	0.45	0.55	0.65	0.45	0.55	0.65	0.30	0.40	0.50	0.30	0.40	0.50
N	16			20			28			32			40		
ND	4			5			7			8			10		
NE	4			5			7			8			10		
JEDEC	VHHB			WHHC			WHHD-1			WHHD-2			-----		

EXPOSED PAD VARIATIONS						
PKG. CODES	D2			E2		
	MIN.	NOM.	MAX.	MIN.	NOM.	MAX.
T1655-2	3.00	3.10	3.20	3.00	3.10	3.20
T1655-3	3.00	3.10	3.20	3.00	3.10	3.20
T1655N-1	3.00	3.10	3.20	3.00	3.10	3.20
T2055-3	3.00	3.10	3.20	3.00	3.10	3.20
T2055-4	3.00	3.10	3.20	3.00	3.10	3.20
T2055-5	3.15	3.25	3.35	3.15	3.25	3.35
T2055M-5	3.15	3.25	3.35	3.15	3.25	3.35
T2855-3	3.15	3.25	3.35	3.15	3.25	3.35
T2855-4	2.60	2.70	2.80	2.60	2.70	2.80
T2855-5	2.60	2.70	2.80	2.60	2.70	2.80
T2855-6	3.15	3.25	3.35	3.15	3.25	3.35
T2855-7	2.60	2.70	2.80	2.60	2.70	2.80
T2855-8	3.15	3.25	3.35	3.15	3.25	3.35
T2855N-1	3.15	3.25	3.35	3.15	3.25	3.35
T3255-3	3.00	3.10	3.20	3.00	3.10	3.20
T3255-4	3.00	3.10	3.20	3.00	3.10	3.20
T3255M-4	3.00	3.10	3.20	3.00	3.10	3.20
T3255-5	3.00	3.10	3.20	3.00	3.10	3.20
T3255N-1	3.00	3.10	3.20	3.00	3.10	3.20
T4055-1	3.40	3.50	3.60	3.40	3.50	3.60
T4055-2	3.40	3.50	3.60	3.40	3.50	3.60

NOTES:

- DIMENSIONING & TOLERANCING CONFORM TO ASME Y14.5M-1994.
- ALL DIMENSIONS ARE IN MILLIMETERS. ANGLES ARE IN DEGREES.
- N IS THE TOTAL NUMBER OF TERMINALS.
- THE TERMINAL #1 IDENTIFIER AND TERMINAL NUMBERING CONVENTION SHALL CONFORM TO JE5D 95-1 SPP-012. DETAILS OF TERMINAL #1 IDENTIFIER ARE OPTIONAL, BUT MUST BE LOCATED WITHIN THE ZONE INDICATED. THE TERMINAL #1 IDENTIFIER MAY BE EITHER A MOLD OR MARKED FEATURE.
- DIMENSION b APPLIES TO METALLIZED TERMINAL AND IS MEASURED BETWEEN 0.25 mm AND 0.30 mm FROM TERMINAL TIP.
- ND AND NE REFER TO THE NUMBER OF TERMINALS ON EACH D AND E SIDE RESPECTIVELY.
- DEPOPULATION IS POSSIBLE IN A SYMMETRICAL FASHION.
- COPLANARITY APPLIES TO THE EXPOSED HEAT SINK SLUG AS WELL AS THE TERMINALS.
- DRAWING CONFORMS TO JEDEC MO220, EXCEPT EXPOSED PAD DIMENSION FOR T2855-3, T2855-6, T4055-1 AND T4055-2.
- WARPAGE SHALL NOT EXCEED 0.10 mm.
- MARKING IS FOR PACKAGE ORIENTATION REFERENCE ONLY.
- NUMBER OF LEADS SHOWN ARE FOR REFERENCE ONLY.
- LEAD CENTERLINES TO BE AT TRUE POSITION AS DEFINED BY BASIC DIMENSION 'e', ±0.05.

-DRAWING NOT TO SCALE-

TITLE: PACKAGE OUTLINE, 16, 20, 28, 32, 40L THIN QFN, 5x5x0.8mm	
APPROVAL	DOCUMENT CONTROL NO. 21-0140
REV. K	2/2

Maxim cannot assume responsibility for use of any circuitry other than circuitry entirely embodied in a Maxim product. No circuit patent licenses are implied. Maxim reserves the right to change the circuitry and specifications without notice at any time.

18 **Maxim Integrated Products, 120 San Gabriel Drive, Sunnyvale, CA 94086 408-737-7600**